

**ACCESS1**  
**ACCESS2**  
454 01.16

# SFA



**SANI ACCESS 1**



**SANI ACCESS 2**

**FR** NOTICE D'INSTALLATION

**UK** INSTALLATION INSTRUCTIONS

**DE** INSTALLATIONSHINWEISE

**IT** ISTRUZIONI PER L'INSTALLAZIONE

**ES** MANUAL DE INSTALACIÓN

**BR** **PT** MANUAL DE INSTALAÇÃO

**NL** INSTALLATIE VOORSCHRIFTEN

**SE** INSTALLATIONSANVISNING

**DK** INSTALLATIONSVEJLEDNING

**NO** INSTALLASJONSANVISING

**FI** ASENNUSOHJEET

**HU** FELSZERELÉSI ÉS KEZELÉSI ÚTMUTATÓ

**PL** INSTRUKCJA INSTALACJI

**RU** ИНСТРУКЦИЯ ПО МОНТАЖУ И ЭКСПЛУАТАЦИИ

**RO** MANUAL DE INSTALARE

**CZ** NÁVOD K INSTALACI A POUŽÍVÁNÍ

**TR** KURULUM KILAVUZU

**CN** 用户应保留安装指南以备用

**KR** 설치내용서

**HR** UPUTA ZA INSTALACIJU

**AR** بي لثرتلا قرط

CE

# SANI ACCESS 1

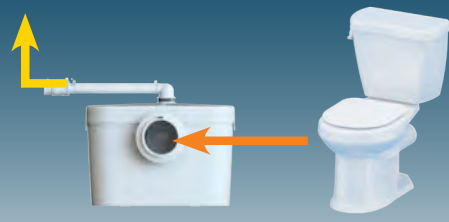

# SANI ACCESS 2

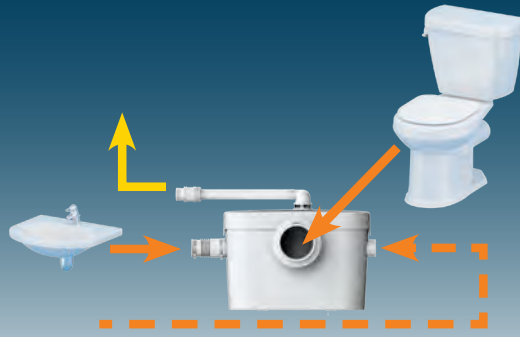

SANIACCESS 2

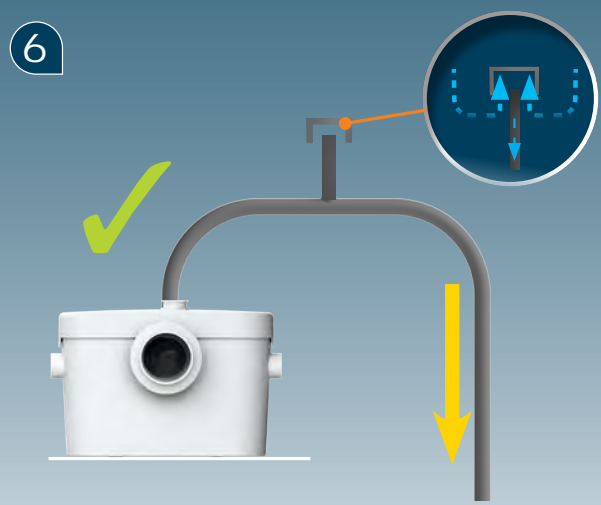
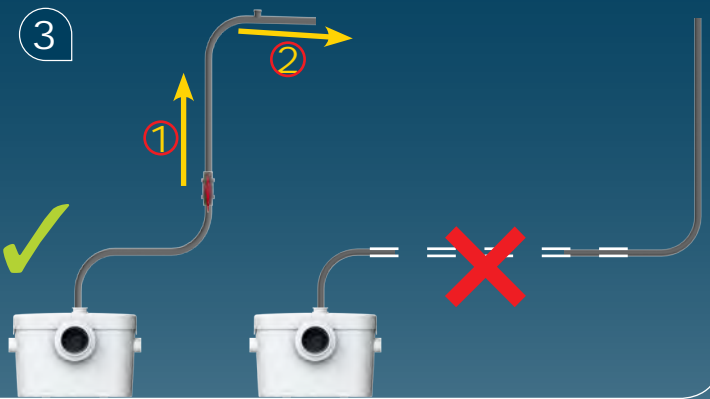
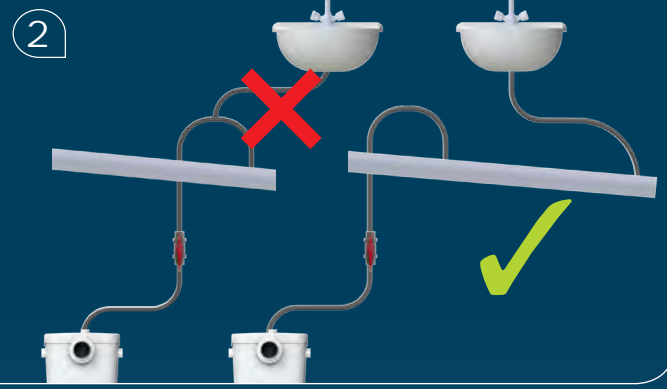
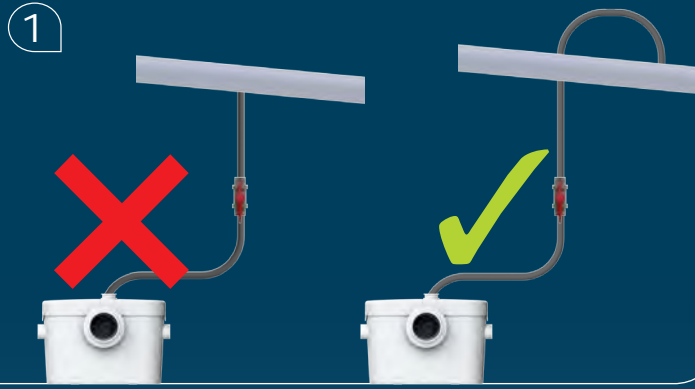

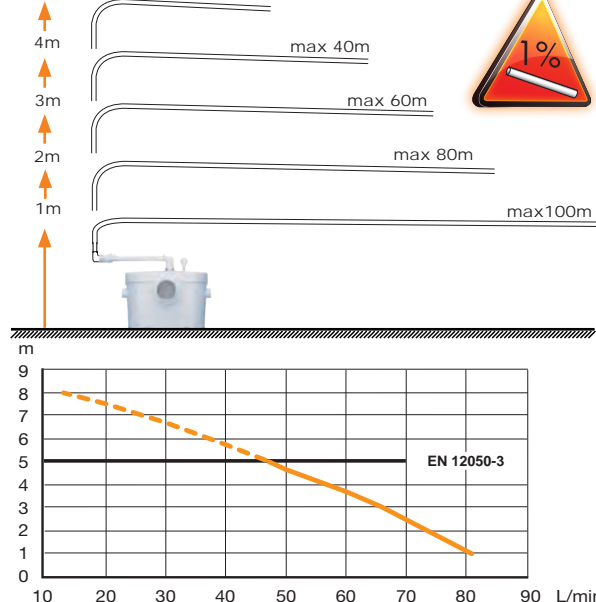
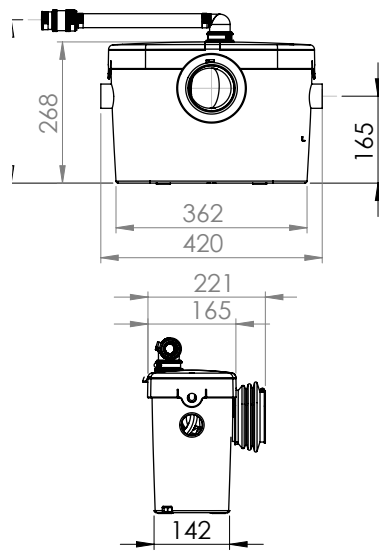
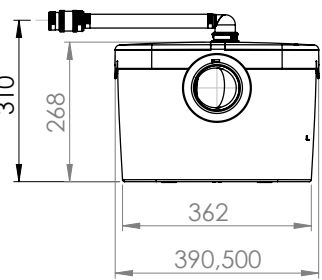

**SANIACCESS1**  
**SANIACCESS 2**  
**EN12050-3 - P30**  
220-240V - 50/60Hz  
400 W  
IP44 - 1,9A - ⚡ - 5,8 kg

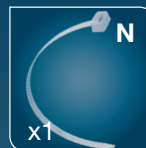
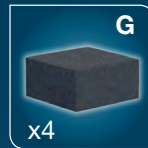
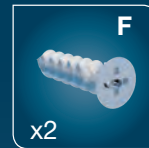
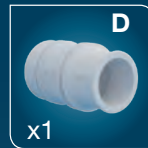
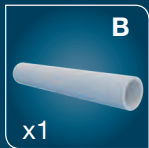

\* SANIACCESS 2

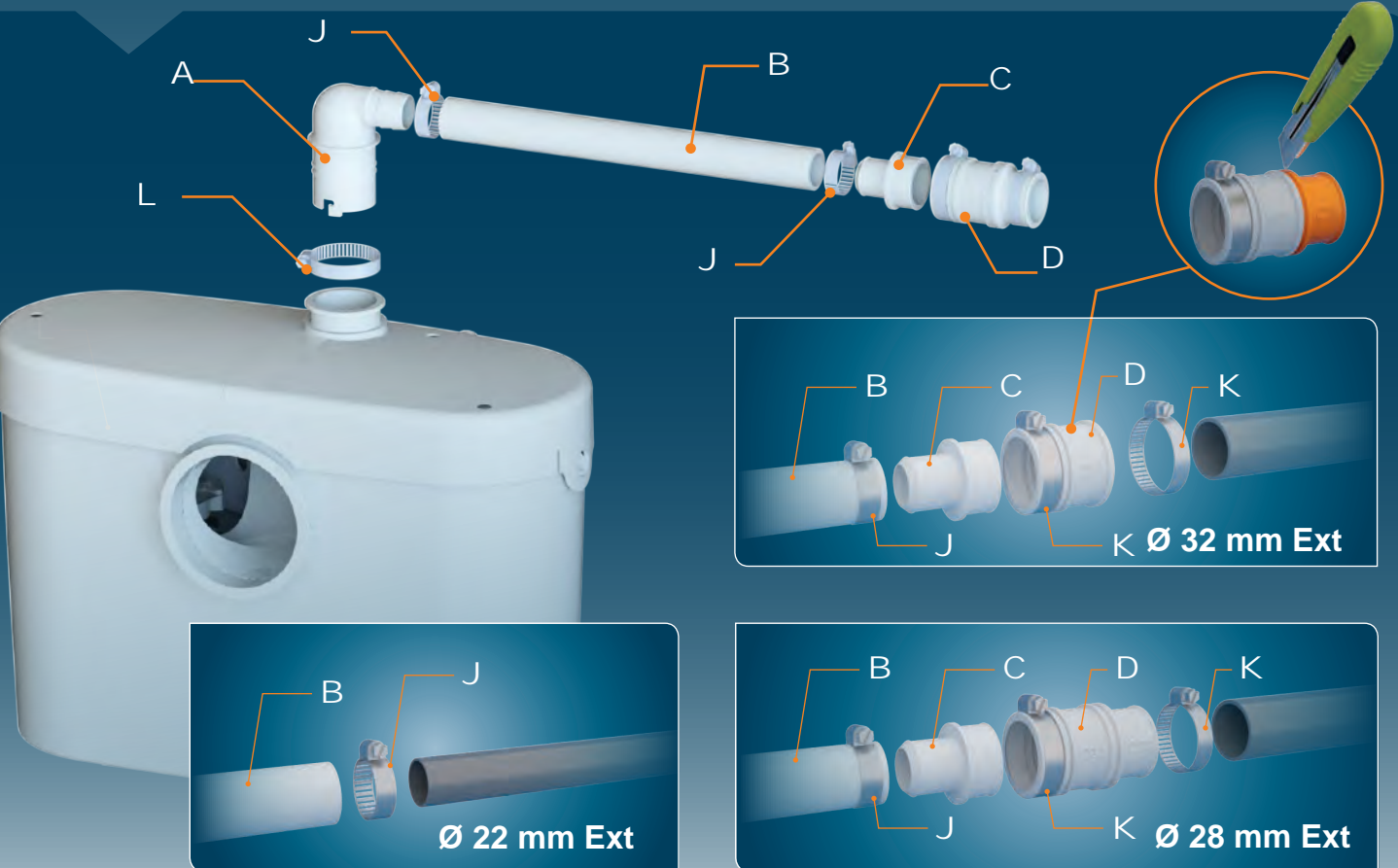

1

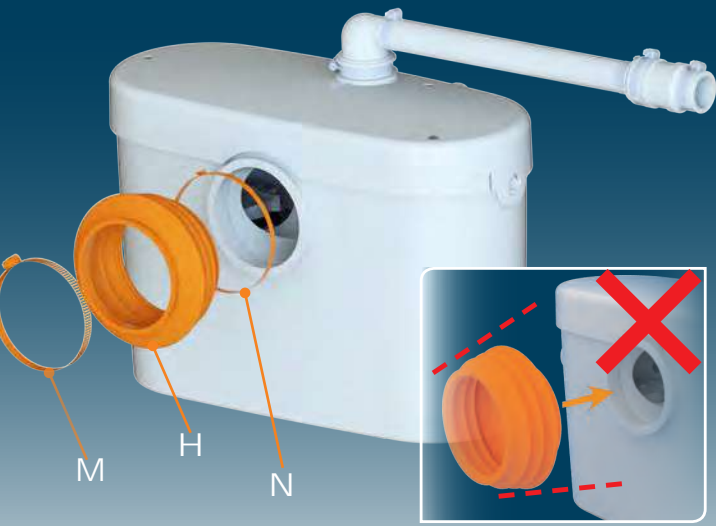

2

SANIACCESS 2



3



4

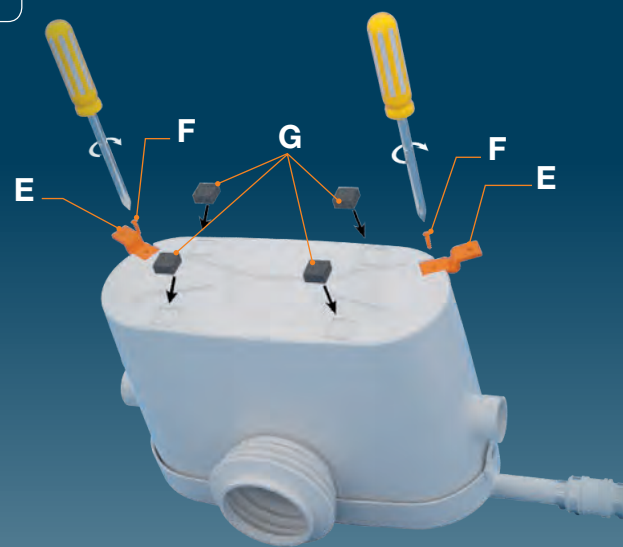

SANIACCESS 2







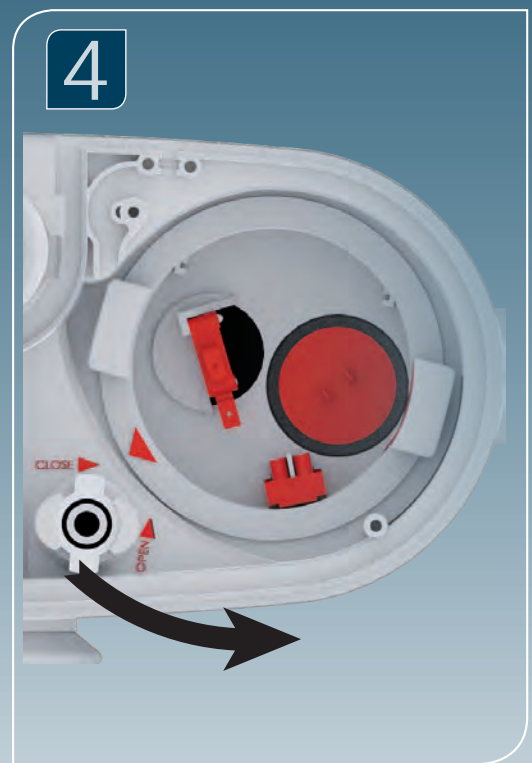
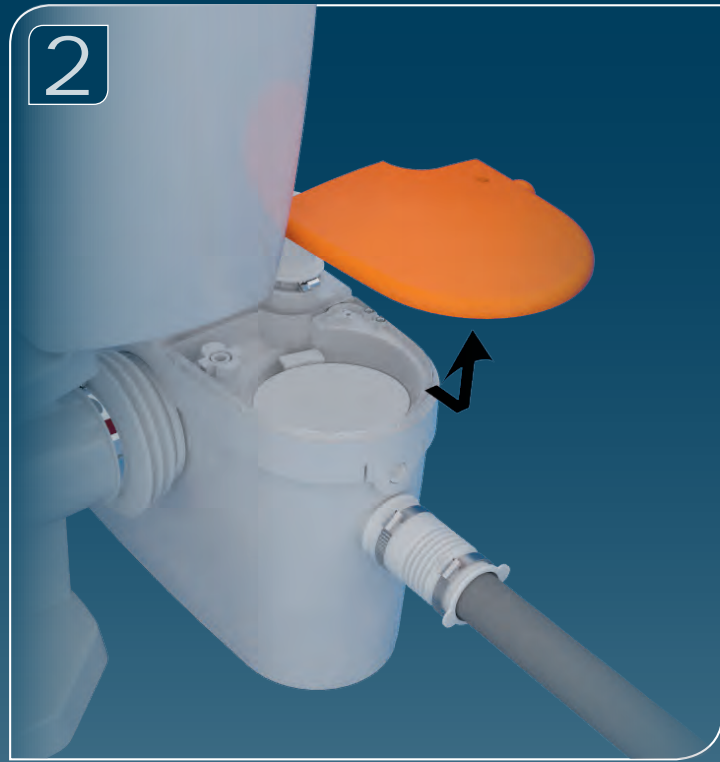

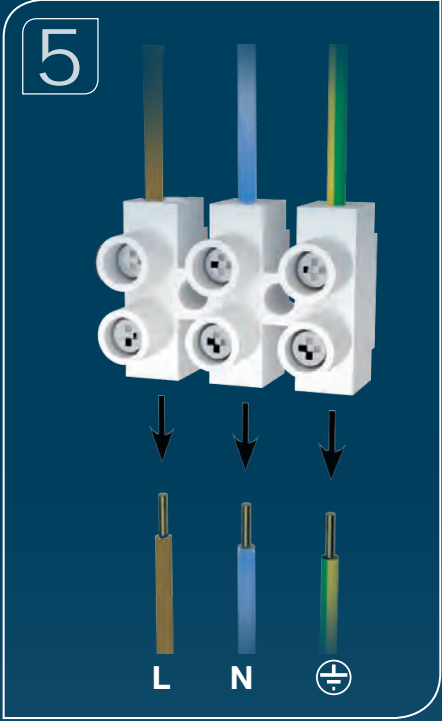

---

---

---

---

---

---

---

---

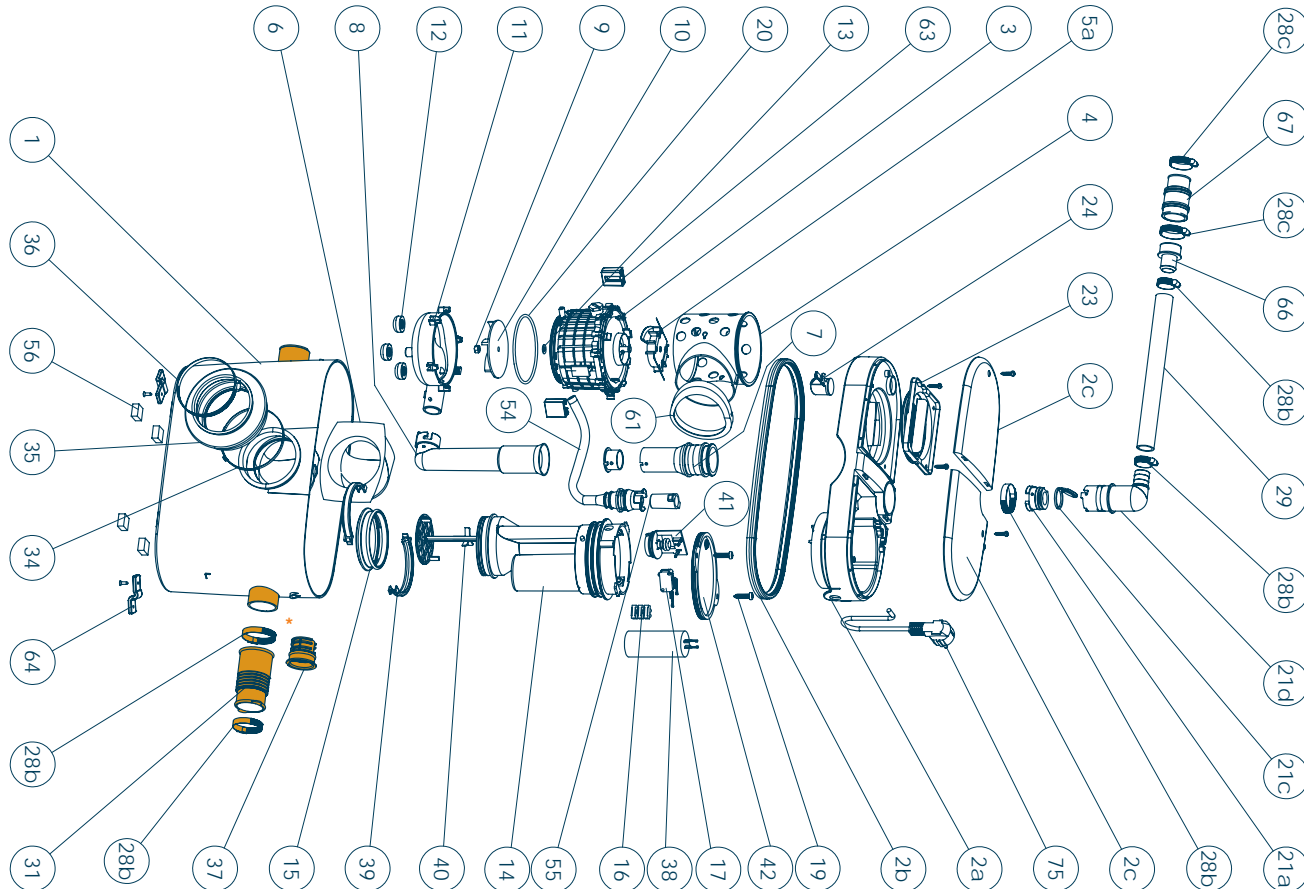

**FRANCE**

**SOCIÉTÉ FRANÇAISE D'ASSAINISSEMENT**  
41 bis avenue Bosquet - 75007 Paris  
Tél. +33 1 44 82 39 00  
Fax +33 1 44 82 39 01

**UNITED KINGDOM**

**SANIFLO Ltd.,**  
Howard House, The Runway  
South Ruislip Middx.,  
HA4 6 SE  
Tel. +44 208 842 0033  
Fax +44 208 842 1671

**IRELAND**

**SANIRISH Ltd**  
IDA Industrial Estate  
Edenderry - County Offaly  
Tel. + 353 46 9733 102  
Fax + 353 46 97 33 093

**AUSTRALIA**

**SANIFLO (Australasia) Pty Ltd**  
Unit 9/10, 25 Gibbes Street  
Chatswood NSW 2067  
Tel. +61 298 826 200  
Fax +61 298 826 950

**DEUTSCHLAND**

**SFA SANIBROY GmbH**  
Waldstr. 23 Geb. B5 - 63128  
Dietzenbach  
Tel. (060 74) 30928-0  
Fax (060 74) 30928-90

**ITALIA**

**SFA ITALIA spa**  
Via del Benessere, 9  
27010 Sizzano (PV)  
Tel. 03 82 61 81  
Fax 03 82 61 8200

**ESPAÑA**

**SFA S.L.**  
C/ Vinyalets, 1 - P.I. Can Vinyalets  
08130 Sta. - Perpètua de Mogoda -  
Barcelona  
Tel. +34 93 544 60 76  
Fax +34 93 462 18 96

**PORTUGAL**

**SFA, Lda.**  
Sintra Business Park, ed.01-  
1ºP2710-089 SINTRA  
Tel. +35 21 911 27 85  
Fax +35 21 957 70 00

**РОССИЯ**

**SFA РОССИЯ**  
101000 Москва - Колпачный переулок 9а  
Тел. (495) 258 29 51  
Факс. (495) 258 29 51

**SUISSE SCHWEIZ SVIZZERA**

**SFA SANIBROY AG**  
Vorstadt 4  
3380 Wangen a. A.  
Tel. + 41 (0)32 631 04 74  
Fax + 41 (0)32 631 04 75

**BENELUX**

**SFA BENELUX B.V.**  
Voltaweg 4  
6101 XK Echt (NL)  
Tel. +31 475 487100  
Fax +31 475 486515

**SVERIGE**

**SANIFLO AB**  
BOX 797  
S-191 27 Sollentuna  
Tel. +46 (0)8-404 15 30  
info@saniflo.se

**POLSKA**

**SFA POLAND Sp. z o.o.**  
ul. Białolecka 168  
03-253 Warszawa  
Tel. (+4822) 732 00 32  
Fax (+4822) 751 35 16

**ČESKÁ REPUBLIKA**

**SFA-SANIBROY, spol. s r.o**  
Na Košince č.ev. 681- 180 00 PRAHA8 -  
Libeň  
Tel. +420 266 712 855  
Fax, +420 266 712 856

**ROMANIA**

**SFA SANIFLO S.R.L.**  
145B Foisorului Street  
District 3  
31177 BUCAREST  
Tel. +40 256 245 092  
Fax +40 256 245 029

**TÜRKIYE**

**SFA SANIHYDRO LTD STI**  
Mecidiye Cad No:36-B Sevencan APT  
34394 MECIDIYEKÖY - ISTANBUL  
Tel. +90 212 275 30 88

**CHINA**

**SFA 中国**  
上海市静安区石门二路333弄3号振安  
广场恒安大厦27C (200041)  
Tel. +86(0)21 6218 8969  
Fax. +86(0)21 6218 8970

**KOREA**

**www.SFA.biz**  
sales@saniflo-korea.kr

**South Africa**

**SFA Africa**  
www.saniflo.co.za

**BRAZIL**

**SFA Brasil Equipamentos Sanitários,**  
Rua Maria Figueiredo 595  
CEP 04002-003 SAO PAULO / SP  
Tel. (11) 3052-2292  
www.sanitrit.com.br

**SERVICE HELPLINES**

	TEL	FAX			
France	01 44 82 25 55	03 44 94 46 19	Benelux	+31 475 487100	+31 475 486515
United Kingdom	08457 650011 (Call from a land line)	020 8842 1671	Sverige	+46 (0)8-404 15 30	
Ireland	1850 23 24 25 (LOW CALL)	+ 353 46 97 33093	Norge	+46 (0)8-404 15 30	
Australia	+1300 554 779	+61.2.9882.6950	Polska	(+4822) 732 00 33	(+4822) 751 35 16
Deutschland	0800 82 27 82 0	(060 74) 30928-90	РОССИЯ	(495) 258 29 51	(495) 258 29 51
Italia	0382 6181	+39 0382 618200	Česká Republika	+420 266 712 855	+420 266 712 856
España	+34 93 544 60 76	+34 93 462 18 96	România	+40 256 245 092	+40 256 245 029
Portugal	+35 21 911 27 85	+35 21 957 70 00	Türkiye	+90 212 275 30 88	+90 212 275 90 58
Suisse Schweiz Svizzera	+41 (0)32 631 04 74	+41 (0)32 631 04 75	中国	+86(0)21 6218 8969	+86(0)21 6218 8970
			Brazil	(11) 3052-2292	



## 1 DESCRIPTION

This macerator is (manufactured in a factory which is quality) certified to ISO 9001. Installed and used correctly, the unit will give consistent and reliable service.

**⚠ This device is not designed for persons (including children) with limited physical, sensory or mental abilities, or those with minimal experience and knowledge, unless they are monitored and are given the necessary instructions for using the device, with the help of a person responsible for their safety. Monitor children and make sure they do not play with the device.**

## 2 APPLICATIONS

This appliance is a compact lift pump unit designed for removing waste water from a horizontal outlet toilet\*, shower\*, bidet\* or washbasin\* (\*: depending on the model). This appliance conforms to EN 12050-3 and the Australian standards concerning electrical safety and electromagnetic compatibility.

To view the DoP (Declaration of performance) please click on the 'Illustrations and Datasheet' tab on each product page on our website.

## 3 INSTALLATION

The unit should be accessible for possible service.

The fitting and working of this appliance must meet local plumbing regulations and the AS3500.2 section 12.

To optimise the latest technical developments concerning soundproofing incorporated into this unit, it is important to:

- position the WC pan so that it is not in contact with a partition or wall of the room
- place the WC pan on a perfectly level surface to ensure that the resilient mounts are fully efficient
- fix the discharge pipe correctly, with distances of not more than one metre between the fastenings.

## 4 CONNECTION TO THE ELECTRICAL SUPPLY

**⚠ The electrical installations should be carried out by a qualified person. The unit requires a 220/240V single phase AC 50 Hz supply . The power supply circuit of the appliance must be earth protected by a 16amp rated RCD, with sensitivity (30mA). Warning: Ensure the power is turned OFF at the main switch before any work is carried out.**

All wiring & GPO positions must conform to Australian Standards for electrical wiring AS3000:2007 requirements for electrical installations.

The connection must be used exclusively to power the device. All work on cable, pressure chamber and motor should only be carried out by a qualified Saniflo servicing agent, as special tools are required. Please do not cut/shorten the electrical supply cable which can make it very difficult to remove in the event of a service requirement.

## 5 COMMISSIONING THE UNIT

Flush the WC checking that all seals, and connections are watertight.

Check both the discharge pipework from the unit and the other sanitary appliances connections. Check the watertightness of connections to sanitary appliances: toilet\*, shower\*, bidet\* or washbasin\* (\*: depending on the model).

## 6 MAINTENANCE CARE OF YOUR UNIT

In order to remove scale and clean the macerator and the bowl, use the SANIFLO descaler.

- Disconnect the macerator power supply,
  - Pour an amount of descaler into the pan
  - Leave it to stand for 1 or 2 hours,
  - Re-connect the macerator power supply,
  - Rinse by operating the flushing system twice.
- Carry out the operation once every 3 months on average, but the frequency may need to be changed depending on the hardness of the water.

## SANIFLO MANUFACTURER WARRANTY

This warranty is provided by Saniflo Australasia Pty Ltd (ABN 55128147240), 10/25 Gibbes Street, Chatswood NSW 2067. Tel: 1300 554 779, email info@saniflo.com.au.

### GENERAL TERMS AND CONDITIONS

This product is to be installed and operated in accordance with the instructions provided. Saniflo warrants its products to be free of defects in material and workmanship during the warranty period. If a product proves to be defective in material or workmanship during the warranty period, then Saniflo will, at its discretion, repair or replace the product with a like product. Replacement product or parts may include re-manufactured or refurbished parts or components. Rights under this warranty sit alongside consumer guarantees under Australian Consumer Law which cannot be excluded.

#### How long the warranty is effective:

This product is warranted for 24 months for parts and labour from the date of purchase by the end user.

#### To obtain warranty service:

Contact Saniflo on 1300 554 779  
Ensure the product is still installed at the original location Provide proof of original purchase, customer name and address, and the installing plumber's details.

Warranty service work may be denied or suspended on equipment not readily accessible to service personnel.

## 7 GUARANTEE

**⚠ Only the disposal of toilet paper, faecal matter, and waste water will be under warranty. Disposal of solvents, paint, acids, caustic liquids, harsh chemicals, hair, food, cotton, sanitary towels, metal, wood, plastic or any foreign objects will void the warranty. The usage of grease or oil will also void the warranty.**



